

AKAI

Makes Sense



6kg Top Load Washing Machine

INSTRUCTION MANUAL

MODEL: AK-6KGTW



Contents

- 03 General Safety Instructions**
- 07 Product Overview**
- 08 Getting Started: Installation**
- 12 Features**
- 14 Instructions**
- 21 FAQs and Troubleshooting**
- 23 Other Useful Information**

General Safety Instructions

IMPORTANT SAFETY INSTRUCTIONS READ CAREFULLY AND KEEP FOR FUTURE REFERENCE

Read this manual thoroughly before first use, even if you are familiar with this type of product. The safety precautions enclosed herein reduce the risk of fire, electric shock and injury when correctly adhered to. Keep the manual in a safe place for future reference, along with the completed warranty card and purchase receipt. If applicable, pass these instructions on to the next owner of the appliance.

Always follow basic safety precautions and accident prevention measures when using an electrical appliance, including the following:



Warning

This heading indicates that there is a serious risk of injury if you do not adhere to the warning(s).



Caution

This heading indicates that care should be taken to avoid injury to persons or damage to property.



A tick in a circle accompanies a measure or action that you should do or follow.



A cross in a circle accompanies a measure or action that you should NOT do.

Electrical safety

- Before connecting and turning on the washing machine, ensure the electrical voltage and circuit frequency correspond to those indicated on the appliance.
- Only connect the washing machine to a grounded (earthed) electrical outlet.
- Do not insert any objects into the appliance.
- Do not kink or damage the power cord, and position it out of the way so no one steps on or places anything on the cord or against it.
- Do not overload the wall outlet. Overloading can result in fire or electric shock.
- If the supply cord is damaged, it must be replaced by the manufacturer or its service agent or a similarly qualified person in order to avoid a hazard.
- Never use this washing machine with a power adaptor or an extension cord.
- Unplug the washing machine from the power supply before cleaning, servicing, maintenance or moving the appliance. Pull by the plug, not by the cord.
- After use, always unplug the appliance and turn off the water.
- **Warning!** All electrical work must be done in accordance with local and national electrical codes as applicable and should be undertaken by licensed and qualified persons only.

General Safety Instructions (Cont.)

Installation

- Install the washing machine on a flat surface to avoid overturning during use. If the machine must be placed on carpet, make sure any ventilation openings in the base are not obstructed.
- Install the washing machine so that there is a distance of at least 200mm between the appliance enclosure and any external heat sources, such as appliances containing heating elements.
- Connect the washing machine to the water mains using new hose sets. Do not reuse old hose sets. Required water pressure is 0.03MPa to 0.8MPa.
- Make sure that all water and electrical connections are made by qualified personnel only, observing local safety regulations and following the manufacturer's instructions.
- Improper installation may result in the risk of fire, electric shock and/or injury. We assume no liability for any eventual damages caused by improper installation.

Usage conditions and restrictions

- This appliance has a capacity (max. weight of dry wash load) of 6kg. The appliance is designed for domestic use only. It is not suitable for commercial or trade use.
- Do not operate the appliance outdoors.
- This appliance is not intended for use by persons (including children) with reduced physical, sensory or mental capabilities, or lack of experience and knowledge, unless they have been given supervision or instruction concerning use of the appliance by a person responsible for their safety.
- Children should be supervised to ensure they do not play with the appliance.
- Before loading the machine, always ensure no pet or young child has climbed into it.
- Make sure all pockets of clothing to be washed are empty. Hard, sharp objects such as coins, safety pins, bra wires, nails, screws or stones can cause extensive damage to the appliance and block the pump.
- Any damage or malfunction resulting from foreign objects is not covered by your warranty and may lead to expensive repairs. We assume no liability for any eventual damages caused by improper or faulty use.

Cleaning and maintenance

- Before cleaning or carrying out maintenance, always unplug the appliance from the power supply.
- Except for the filters that require regular cleaning, the unit has no user-serviceable parts contained within. Do not attempt to repair, disassemble or modify it. Repairs made by inexperienced or unqualified persons may cause injury and/or make more serious repairs to the appliance necessary.
- **CAUTION:** After each wash, check and clean the lint filter inside the drum. Also check and clean the drain pump filter at the back of the machine next to the drain hose outlet on a regular basis.
- This appliance should only be serviced by an authorised service centre, and only genuine spare parts should be used. Contact our after sales support centre for advice.

General Safety Instructions (Cont.)

Warnings

Do not let children climb into the washing machine or peer into the rotating spin barrel.



Do not wash clothes that have residue of flammable materials.



Do not use the appliance if the power cord or plug is damaged to avoid an electric shock, short circuit or fire.

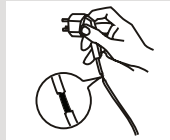

Regularly clean the power plug to remove dust and dirt and avoid contact failure.

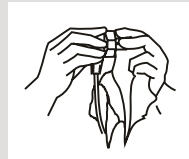

Turn the machine off before pulling out the plug from the socket if the machine is not in use.

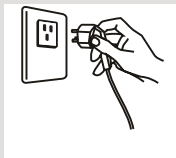

Do not place any flammable items on top of the washing machine.



Insert the power plug securely.

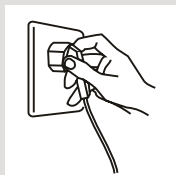

Use a 230-240V~ power source.

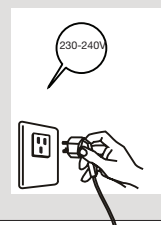

General Safety Instructions (Cont.)

To avoid electric shock, fire and malfunction, do not install this machine in a damp place.



No dampness



Do not pull out or insert the plug with wet hands to avoid electric shock.

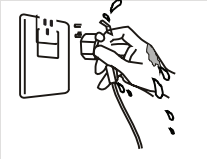



No wet hands





Cautions



Ensure the water inlet hoses are connected and the taps are turned on before washing a load.





Do not allow children to lay or sit on top of the washing machine.





Do not change the power cord. If it needs changing, contact a licensed electrician or contact our after sales support centre.



Do not wash jackets, raincoats, fishing coats and similar clothes in the washing machine.



Do not pull the power cord when removing the plug.



The water temperature should not exceed 60°C when washing with warm water.

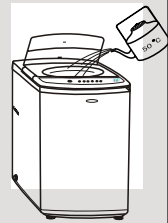

Product Overview

Scope of delivery

- 1 Transparent lid
- 2 Control panel
- 3 Housing
- 4 Detergent box
- 5 Lint filter
- 6 Wash/spin tub
- 7 Softener dispenser
- 8 Spirit level
- 9 Adjustable leg (1)
- 10 Water supply hose connections
- 11 Power cord and plug
- 12 Drain pump filter and cap
- 13 Drain hose connection

Inside view

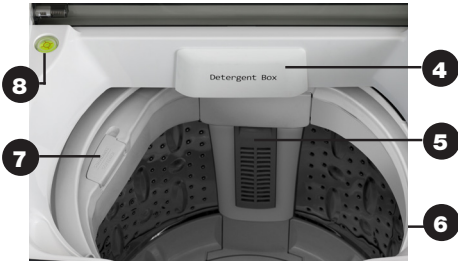

Front view



Back view

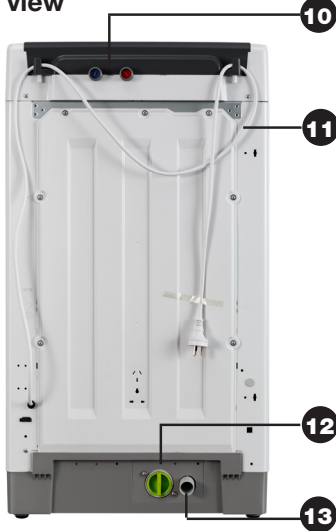

Accessories included

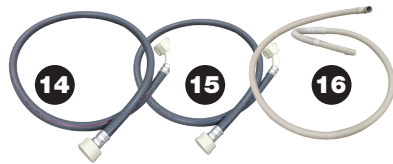

- 14 Hot water supply hose
- 15 Cold water supply hose
- 16 Drain hose with elbow
- 17 Base cover and screw for attaching the base cover to the unit (not shown)

Documentation (not shown)

- Instruction manual
- Warranty certificate

After Sales Support

Getting Started: Installation

Unpacking

- This product has been packaged to protect it against transportation damage. Keep the original packaging carton and materials in a safe place. It will help prevent any damage if the product needs to be transported in the future. In the event it is to be disposed of, please recycle all packaging materials where possible.
- Plastic wrapping can be a suffocation hazard for babies and young children, so ensure all packaging materials are out of their reach and disposed of safely.
- Unwind the power cord to its full length and inspect it for damage. Do not use the appliance if the appliance or its cord have been damaged or are not working properly. In case of damage, contact our after sales support centre for advice on examination, repair or return of the damaged product.
- Read this manual to familiarise yourself with all the parts and operating principles of the washing machine. Pay particular attention to the safety instructions on the previous pages.

Installing the base cover

- Make sure the power cord is unplugged from the mains supply.
- Place some padding (such as a soft mat, blanket or thick towel) on the floor and gently lay the washing machine on the padding, back side down. Take care not to dent the housing.
- Insert the base cover into the hooks of the leg, pushing it straight until it reaches into the front hooks.
- Fasten the bottom cover with the supplied screw.
- Carefully set the washer upright.

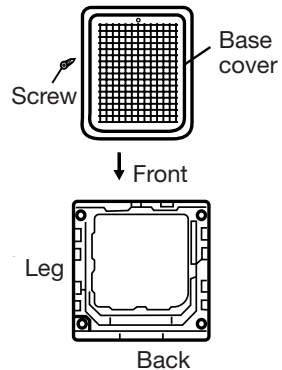

Levelling the washer

- Install the washer on a stable and level surface, in a dry location, out of sunlight.
- Open the lid to reveal a spirit level on top of the housing, which will help you level the appliance.
- If levelling is necessary, adjust the adjustable leg (at the front right side of the machine), as illustrated, right. The maximum permissible inclination of the supporting surface is 2 degrees.
- **CAUTION:** If you must install the washer on a carpeted floor, make sure you are not blocking any ventilation openings on the underside.

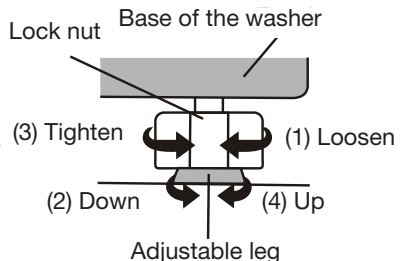

Getting Started: Installation (Cont.)

Connecting the water inlet hoses

Install the water inlet hoses to your hot and cold water taps, as described below.

- Check and ensure that the sealing washers are firmly in place.
- Attach the straight end of the hose to your water taps. Make sure to attach the hot water supply hose (with **red** markings) to the hot water tap and the cold water supply hose (with **blue** markings) to the cold water tap.
- Tighten the coupling nuts securely by hand, as illustrated below (the sealing washer is a part of and located inside the tap end).

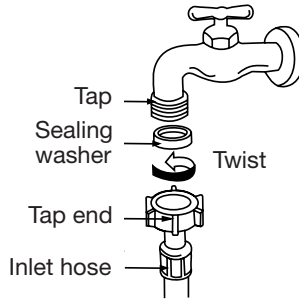

- Attach the curved end of the hose to the corresponding inlet valve of the washer.
- Tighten the coupling nuts securely by hand, as illustrated below.
- Tighten the nut by turning it clockwise while holding the hose. (To detach the water supply hose, turn the nut anticlockwise after turning the tap off.)



- Turn on the taps and check for leaks. Tighten the coupling nuts firmly if there is any leakage. If your water pressure is strong, close the water tap completely, then open it slightly.
- Make sure your hot water from the tap is no hotter than 60°C.

IMPORTANT!

Both the hot water and cold water hoses must be connected to your taps.

NOTE: The drawings throughout this manual are for illustrative purposes only and may vary slightly from the appearance of the unit purchased.

Getting Started: Installation (Cont.)

⚠ CAUTION! When tightening the clamping nut, take care not to damage the water inlet valve joint. Apply force evenly and do not twist the water inlet valve.

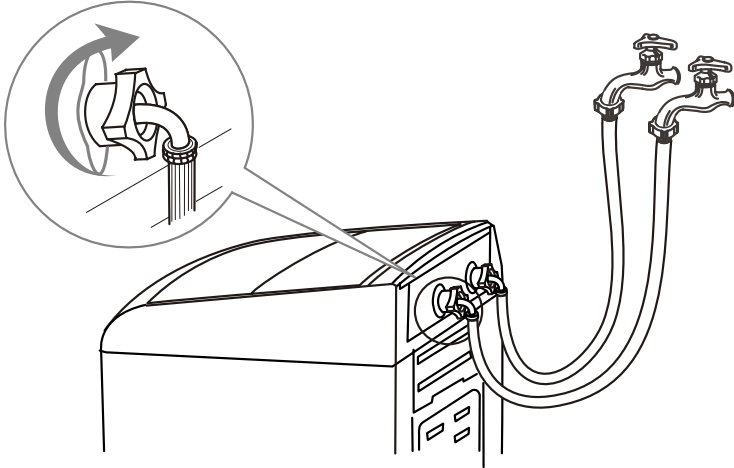

⚠ CAUTION! Use only the new (supplied) hoses with your new appliance. Do not use a hose from an existing machine, or one that has been used previously.

⚠ CAUTION! In the event that the hoses are too short for your set-up, please seek advice from your local washing machine store to purchase a longer hose.

Installing the drain hose

- The drain hose and drain pump filter are located at the back of the machine, as illustrated below, left.
- Pinching the two bands of the clamp on the drain hose, connect it to the drain hose connection at the back of the washer, as illustrated below, right.
- When the washer is in use, pull the drain hose upward and put it into a drain spout (or into a sink/tub), as illustrated on the opposite page.

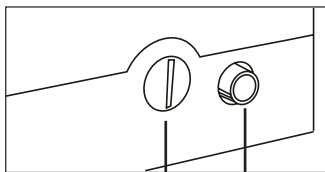

Drain pump with lint filter

Drain hose connection

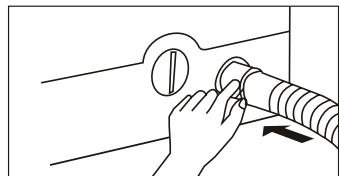
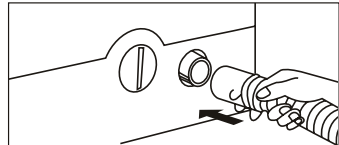

Getting Started: Installation (Cont.)

CAUTION!

- While the washer is in use, ensure the height of the drain hose is at least 70cm, otherwise the washer will not work well, or water may flow out in the course of washing.
- Also ensure the drain hose is not higher than 1m above ground, otherwise the washer will not drain water well.
- Never lay down the drain hose, as water will be discharged.
- Be sure the drain hose is properly routed so it will not kink or lift off the sink.

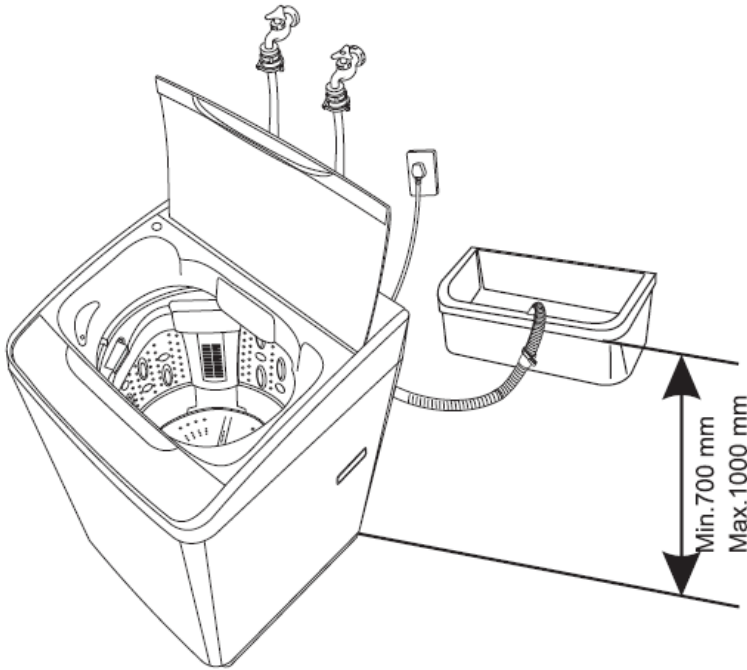

WARNING: this appliance must be earthed

In the event of a malfunction or breakdown, earthing will reduce the risk of an electric shock by providing a path of least resistance for the electric current.

This appliance is equipped with a cord having an equipment-earthing conductor and an earthing plug. The plug must be plugged into an appropriate outlet that is installed and earthed in accordance with all local standards and requirements.

WARNING: Do not modify the plug under any circumstances. If the plug does not fit your outlet, consult a licensed electrician and have the outlet changed.

Features

The control panel

Detergent indicators

- These indicate how much powder detergent to use.
- See 'Detergent and load recommendations' for details.

Indicator lights

- The wash process indicator lights indicate the current wash process (delay, soak, wash, rinse, spin).
- The program lights indicate the selected wash program (custom, normal, heavy duty, quick, blanket, delicate).

Water level button

- You can choose the appropriate water level that matches the load size.
- Different water levels for washing or rinsing are optional.
- See 'Setting the water level ...' for details.

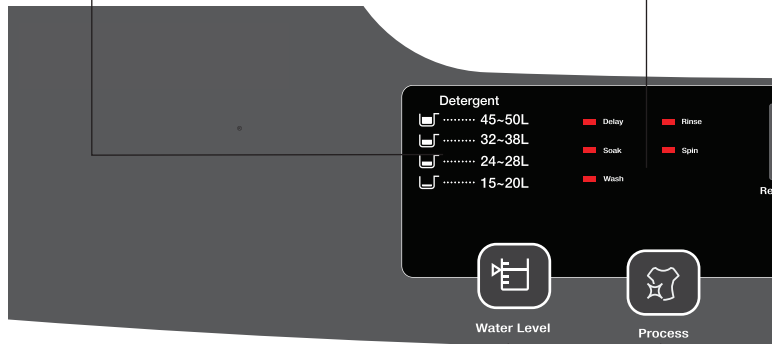

Process button

- Press the PROCESS button to set a variety of wash processes: Delay, Soak, Wash, Rinse, or Spin.
- The indicator for the selected option will illuminate above.

Set button

- Press the SET button to set the Delay time and the Soak, Wash, Spin and Rinse times.

Program button

- Press the PROGRAM button to select the washing program.
- **NOTE:** For the NORMAL and HEAVY DUTY programs, the machine will automatically select the appropriate water level and wash and spin times.

Features (Cont.)

Time and preset indicators

This indicator shows the remaining time during washing.

(E.g.) Remaining time is 20 minutes

20

When setting soak and wash processes, this indicator shows the time or water level you set.

(E.g.) Washing time is 10 minutes

10

This indicator shows during presetting when the washing will be finished.

(E.g.) Finish washing 2 hours later

2

When abnormal conditions occur, an error warning will appear here.

(E.g.) Water does not flow

E1

Start/Pause button

- Press this button to start the washer operation.
- During operation, press this button to stop the washer temporarily; press it again to restart the washer operation.

NOTE: This is not a CANCEL button.

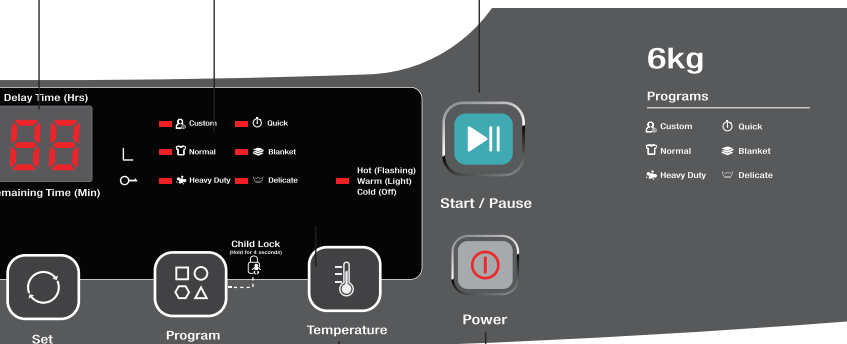

Temperature button

- Press this button if you want to choose the water temperature. The indicator above will alight (for warm) and flash (for hot) water. When the indicator is off, cold water is selected.

Power On/Off button

- Press this button to switch the power on; press it again to switch it off.
- To change the program, press this button once and then once more.
- Power will be switched off automatically:
 - (a) five seconds after the end of a program;
 - (b) after 10 minutes of inactivity, after the POWER button has been pressed.

Instructions

Before you start washing

- A Make sure the washer is stable and level. If necessary, adjust the adjustable leg to stabilise the washer).
- B Make sure the water inlet hoses are properly installed.
- C Plug the machine into a nearby power point.
- D Open the water taps.
- E Make sure the drain hose is properly installed. Hang the upper end of the hose over the drain spout.

- F **Before using the washing machine for the first time, run a complete cycle without laundry items and detergent.** Select the NORMAL program and run the machine until the end of the program.

Normal usage

1. Before washing, remove any coins, keys and other hard items from pockets. Close any zippers to prevent damaging your clothes and the wash tub. Brush dirt and sand off clothes and turn pockets inside out.
2. Sort your washing into appropriate loads: whites, coloureds, cottons, delicates, heavily soiled, etc. Place delicate items into a wash bag for protection.
3. Put your washing in the machine, loading items uniformly in the tub.
4. Add washing detergent (see opposite for details).
5. Press the POWER ON/OFF button.
6. Refer to the Program Selection Guide (opposite) and select a suitable wash program. **The machine will automatically choose the correct water level and wash and spin times for the NORMAL and HEAVY DUTY programs, and the correct water level for the CUSTOM and QUICK programs.** Other parameters can be set individually.
7. Close the lid and press the START/PAUSE button.

NOTE: If the washer lid is not closed properly, the washer will sound an alarm and stop working before spinning.

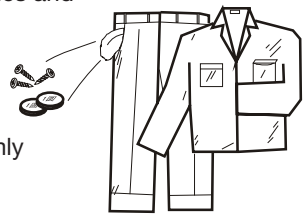
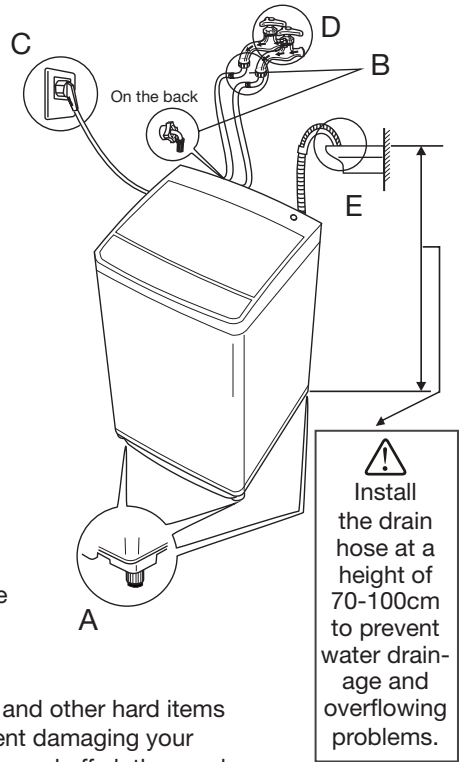

Instructions (Cont.)

Program selection guide





Program	Suitable items	Default settings for wash processes		
		Wash time	Number of rinses	Spin time (minutes)
Custom	All kinds of clothes	10 minutes	2	5 minutes
Normal *	Normally soiled cottons	5–12 minutes #	2	5–6 minutes #
Heavy Duty	Heavily soiled cottons	7–14 minutes #	2	7–8 minutes #
Quick	Not very dirty clothes for daily wash	5 minutes	1	3 minutes
Blanket	Blanket or bulky items	12 minutes	2	8 minutes
Delicate	Delicate fabrics	6 minutes	2	2 minutes

* This program has been used for energy testing (with warm water and on the highest water level setting).

The NORMAL and HEAVY DUTY programs are specially designed for 100% fuzzy control. As the wash and spin times are determined by the load sensor, there is no default display. If you do not adjust, the washer will run within the default interval, depending on the sensor result.

Detergent and load recommendations

- We suggest you use detergent in the amounts recommended below. Too much will affect rinse performance and too little will give poor washing results.
CAUTION: Do not overfill detergent as this may cause overflow of suds, which could interfere with machine operation!
- Add detergent into the detergent box or put it directly into the tub.
- Dilute fabric softener with a little water and carefully add it to the softener dispenser on the balance ring for dispersion through the final rinse.

Water level indicator	15	20	24	28	32	38	45	50
Water volume	15L	20L	24L	28L	32L	38L	45L	50L
Detergent indicator								
Amount of powder detergent	10–20g		20–28g		28–36g		36–45g	
Liquid detergent	When using a liquid detergent, follow the recommendations on the detergent packaging for a top load washing machine.							

Instructions (Cont.)

Customising a program

This washing machine is equipped with a fuzzy logic function that will automatically choose the correct water level and wash and spin times for the NORMAL and HEAVY DUTY programs, and the correct water level for the CUSTOM and QUICK programs. If you want to adjust these values yourself, proceed as follows:

1. Prepare your washing according to points 1 to 4 on page 14.
2. Press the POWER ON/OFF button.
3. Press the PROGRAM button to select the washing program appropriate for your washing load.
4. Press the PROCESS button to select the process; the relevant indicator light will illuminate when the option is selected. Then press the SET button and set the time.

- SOAK time options

0 → 5 → 10 → → 35 → 40 Minutes (Soak time cannot be adjusted for the DELICATE and BLANKET programs.)

- WASH time options

0 → 1 → 2 → → 19 → 20 Minutes

- RINSE times options

0 → 1 → 2 → → 4 (The number is the number of rinses.)

- SPIN time options

0 → 1 → 2 → → 8 → 9 Minutes (For the DELICATE program, spin time can only be adjusted up to 3 minutes, as illustrated.)

0 → 1 → 2 → 3 Minutes (DELICATE)

5. Press the WATER LEVEL button and choose an appropriate water level.
6. Close the lid and press the START/PAUSE button for the washing program to start.
7. At the end of the washing program, a buzzer will sound to alert you that the program has finished before the power is shut off automatically.
8. Close the water taps and unplug the power plug from the wall outlet.

Instructions (Cont.)

The blanket program

Use this program for washing blankets or other bulky items. It will automatically select the highest water level, but you can adjust this manually down to a lower level according to the size of your bulky item(s).

1. Press the POWER ON/OFF button and open the washer lid.
2. Press the PROGRAM button repeatedly and until the indicator for the BLANKET program flashes.
3. Dissolve an appropriate amount of washing detergent with a little lukewarm water, then pour the detergent solution directly into the tub of the washing machine.
4. Fold up the blanket and put it into the washing tub, as illustrated below.

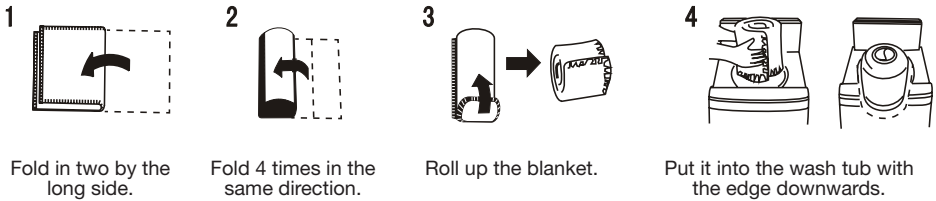

1 Fold in two by the long side.

2 Fold 4 times in the same direction.

3 Roll up the blanket.

4 Put it into the wash tub with the edge downwards.

5. Close the washer lid.
6. Press the START/PAUSE button for the washing program to start.
7. At the end of the washing program, a buzzer will sound to alert you that the program has finished before the power is shut off automatically.
8. Close the water taps and unplug the power plug from the wall outlet.
9. We recommend cleaning the lint filter after washing a blanket.

NOTE: If you notice that the blanket floats up during the wash, press the START/PAUSE button, the washer will stop working temporarily. Push the blanket down and press the START/PAUSE button again to continue washing.

Selecting a wash cycle process

On occasion you may want to select a single wash cycle process (or two processes) instead of a complete program. For example, you may want to spin clothes that got wet from rain while hanging on the line, or rinse and spin clothes washed by hand.

- **To set a spin cycle only**, set the SOAK, WASH and RINSE options to “0” and then select a SPIN time (from 0-9 minutes). Then proceed as described opposite.
- **To set a rinse and spin cycle**, set the SOAK and WASH options to “0”, then select a RINSE option (from 1 to 4) and a SPIN time (from 0-9 minutes). Then proceed as described opposite.

Instructions (Cont.)

Delayed washing

This washing machine has a 0–24 hour delay start function which you can set to determine the time when the washing program will finish.

NOTES: * This function is not available for the DELICATE program.

* To avoid water leakage when using this function, make sure the water taps are open, the drain hose is properly installed and the washing load and detergent are properly prepared.

1. Put your washing in the machine, loading items uniformly in the tub.
2. Press the POWER ON/OFF button.
3. Select the required PROGRAM and/or PROCESS.
4. Press the PROCESS button until the Delay indicator light flashes, then press the SET button to select the desired time period (in hours) for the wash to finish.
5. Select the water level, if necessary.
6. Add any detergents.
7. Close the washer lid and press the START/PAUSE button.
8. After setting the delay, the corresponding light will illuminate and all other lights will be switched off about one minute later. From this time on until the delayed time only the POWER and SET buttons will respond when pressed.
9. To check the delayed program, press the SET button: the program will be indicated for 5 seconds. During these 5 seconds you can press the WATER LEVEL button and set the water level.
10. To cancel the delay, shut off the power.
11. To change the delay time, first cancel the delay, then set it again.

Adding detergent to a delayed wash

When using the delayed wash, we recommend you do not add detergent directly to the wash tub but follow the instructions below:

- **Powder detergent:** either put powder detergent into the detergent box or, if you prefer to put it directly into the wash tub, wrap the powder in a small cloth.
- **Liquid detergent and bleach:** pour liquid detergent or bleach into the hole on the pulsator. Do not pour it directly into the tub as it may cause discolouration of your washing.
- **Fabric softener:** dilute the softener with twice the amount of water, then pour the solution into the softener dispenser on the balance ring.

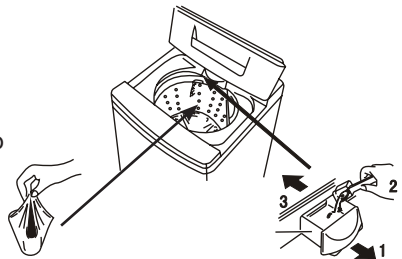

Instructions (Cont.)

Other functions

Hot / cold / warm water wash

This top load washing machine must be connected to both a cold and a hot water tap. With both hoses connected to a cold and hot water tap, you can set the washer to use either just cold water for a cold water wash, or just hot water for a hot water wash, or both hot and cold water for a warm water wash.

To select the wash temperature, press the TEMPERATURE button.

- **Cold wash:** the indicator light is off.
- **Warm wash:** the indicator light is on.
- **Hot wash:** the indicator light is flashing.

Setting the water level and other processes

You can set the water level for wash and rinse processes. For example, if you are sensitive to detergent residues in your washing, you may want to select a higher water level for rinsing.

To set different water levels:

- Press the PROCESS button until the WASH light flashes; press the WATER LEVEL button to choose the appropriate water level (it will be shown on the display screen); press the SET button to set the wash time.
- Then press the PROCESS button until the RINSE light flashes; press the WATER LEVEL button to choose the appropriate water level; press the SET button to set the number of rinses.

To set other processes:

- Then press the PROCESS button until the SPIN light flashes; press the SET button to set the SPIN time.
- Finally press the START/PAUSE button: the washer will start operating according to the set values for wash and rinse water levels, number of rinses and spin time.

Instructions (Cont.)

Load sensor (fuzzy control)

This washing machine is equipped with a fuzzy logic function that will automatically detect the weight of your wash and choose the correct water level and wash and spin times for the NORMAL and HEAVY DUTY programs, and the correct water level for the CUSTOM and QUICK programs. You do not have to set these values; however, if you want adjust them yourself, see page 16 for how to customise processes.

Child lock

With the child lock activated, the machine will stop working automatically and sound an alarm if the washer lid is opened for 5 seconds.

To set the child lock:

- Press the POWER ON/OFF button to switch on the power, then press and hold the PROGRAM button for 4 seconds until a buzzer sounds. The child lock will be activated when the START/PAUSE button is pressed.
- To cancel the child lock, repeat the above steps.

Start of washing

The machine will start washing when the water inside the tub has reached two levels below the set level while the water will continue to flow in.

This early start of washing will increase the wash time and allow the detergent to dissolve fully before the start of the set wash time.

This function will be ineffective:

- When the first two water levels (15L or 20L) are selected.
- When the DELICATE or BLANKET program is selected.
- When SOAK is selected, after the soaking process.

FAQs and Troubleshooting

Not all unusual incidents you may encounter with your washing machine are faults, or cause for concern. Check in the list below what issues may arise and why. Also check in the table on the following page for solutions to other common problems.

- **The drain hose is leaking water during the first use. Does this indicate there is a problem?**
No, this is normal; it is residual water from the performance test in the factory and no cause for concern.
- **Why is there still some water intake during the wash or rinse cycle?**
When the water level is low, the washing machine will automatically refill during the washing or rinsing process. This is no cause for concern.
- **At the beginning of the spin cycle, why is the tub turning first and then stopping?**
This is intermittent spinning and it results in better spinning performance.
- **During the spin cycle, why is the machine spinning and then stopping suddenly and taking in water again?**
If the washing is piled up at one side of the tub during the spin cycle, the washing machine automatically takes in more water to redistribute the load. Once the load is balanced again, the spin cycle will continue.
- **Why is there a sound like water flowing after spinning?**
This is the sound of the balancing liquid in the balance ring. This helps reduce vibration during spinning.
- **Why is the control panel still warm after the power is switched off?**
This is caused by the memory circuitry still working.
- **The washer does not work at all. What could I have done wrong?**
 - Check and ensure that the washer is connected properly to the power supply and power is switched on at the outlet.
 - If both are OK, first press the POWER ON/OFF button, then press the START/PAUSE button.
 - If the machine still does not start the set program, check elsewhere in your home whether there has been a power failure, or whether the fuse or circuit breaker has been activated.

If none of the solutions offered above and on the following page help you solve the problem, contact our after sales support centre for advice.

FAQs and Troubleshooting (Cont.)

Error messages

When the following problems occur, the microcomputer inside the washer will detect the abnormal condition. An electronic buzzer will sound for approximately 10 seconds, an error message will flash as shown below and the washer will stop operating.

Type of problem	Error message	Where to check
Water does not flow into the wash/spin tub.	E1	<ul style="list-style-type: none">• Turn on the water supply tap.• Check whether the water supply has been cut off.• Check whether the mesh filter of the water inlet is clogged.
Water does not drain out.	E2	<ul style="list-style-type: none">• Check and make sure the drain hose is properly connected and installed.• Check the drain hose for kinks or obstructions.• Check whether the drain hose is clogged.• Check whether the drain hose is installed too high off the ground.• Check whether the filter of the drain pump is clogged.• Check the lint bag filter inside the drum is clean (empty).• Check the lint filter at the lower back of the machine is not obstructed.
The washer does not spin.	E3	<ul style="list-style-type: none">• Check whether your washing is piled at one side of the tub. If so, redistribute the load evenly inside the tub.• Check and make sure the washer is installed on an even, level surface.
	E4	<ul style="list-style-type: none">• Close the washer lid.
The buzzer keeps buzzing.	E5	<ul style="list-style-type: none">• Check whether the child lock is set.• Close the washer lid.
Other problems.	EA EC	<ul style="list-style-type: none">• Press the POWER ON/OFF button to turn off the power, then contact our after sales support line to arrange a service.

NOTE: Press the START/PAUSE button once to release the emergency stop and cancel the error message; press it again to restart the operation.

Other Useful Information

Cleaning and care

To prolong the service life of the washing machine, keep it in good condition and perform regular maintenance. **For any type of cleaning and maintenance, make sure the washing machine is disconnected from the mains power supply.**

Cleaning the washing machine (when required)

- Use a soft cloth to wipe any water or dirt off the washer lid and housing. If using a damp cloth, squeeze it almost dry to avoid leaving water residues.
- The detergent drawer may be pulled out for cleaning, if required. Other inside parts should be wiped with a damp cloth, if necessary.
- Do not use any chemical, alkaline or abrasive cleaning agents to avoid damaging the surface. Do not spray water directly onto the washer housing.

IMPORTANT!

If you frequently use a COLD wash cycle, you will need to clean the inside of your washing machine regularly (every three months), especially if you use a fabric softener. Liquid detergents can cause detergent scum to build up around the outside of the inner tub, which cold water will not remove and which can cause bacteria, unpleasant odours, and eventually soiling of your wash load.

To remove scum build-up from the inside of a washing machine, run a cleaning cycle without clothes using the Heavy Duty program and hot water. As a cleaning agent, use a commercially available washing machine cleaning product (such as **Trimat Washing Machine Cleaner**) according to the instructions on the product), or use a mix of bicarbonate of soda (½ cup) and white household vinegar (2 cups).

Other Useful Information (Cont.)

Cleaning the lint filter (suggested interval: every week)

Take out the lint filter as illustrated below. Open the filter and rinse it clean under running water, taking care not to damage any parts. Reinstall the filter, making sure it fits securely behind the cover clasp and latches and locks securely into place.

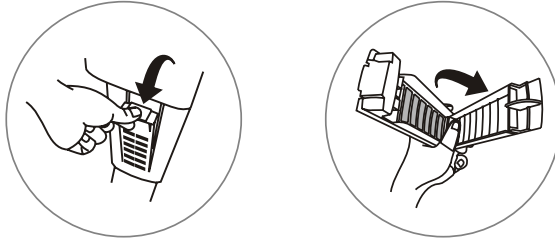

Cleaning the water inlet valve (suggested interval: every 6 months)

To avoid blockage of the mesh filter at the water inlet after long time use, detach the water inlet hose, making sure you have turned off the water supply at the taps beforehand. Take the mesh filter out of the water inlet valve and clean the filter with a soft brush. Then assemble the mesh filter back into the valve and reconnect the water inlet hose.

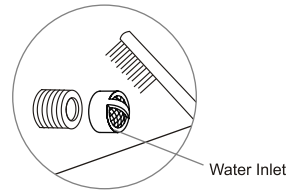

Cleaning the hose filter (suggested interval: every 6 months)

To avoid blockage of the hose filter after long time use, detach the water inlet hose, making sure you have turned off the water supply at the taps beforehand. Turn the nut anticlockwise to take off the hose, clean the filter under running water or with a soft brush, then reconnect the hose.

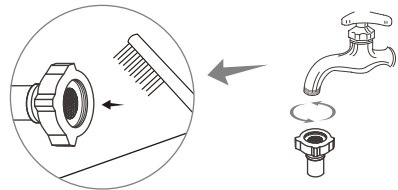

Other Useful Information (Cont.)

Drain pump maintenance

We recommend that you clean the drain pump filter regularly (at least once a month) to avoid blockages created by bobby pins, coins and excess lint.

Proceed as follows:

1. Disconnect the washer from the power source.
2. If necessary, wait until the water has cooled down.
3. Place a container underneath the pump opening to collect any spillage (see below, left).
4. Turn the filter cap anticlockwise to take it out gently (see below, right). Always keep a rag nearby to dry up water spillage when removing the pump filter.

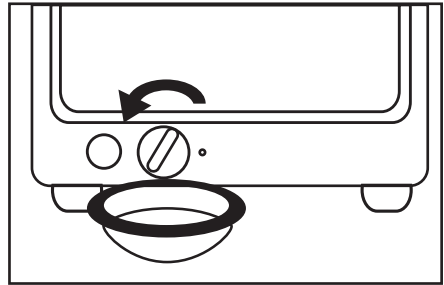
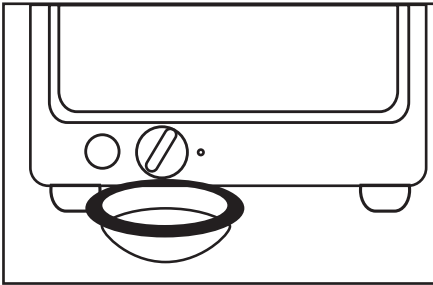

5. To remove any objects from the filter, wash it thoroughly in a basin or under running water (see below, left).
6. Put the cap back and place the filter back in its seat (see below, right).

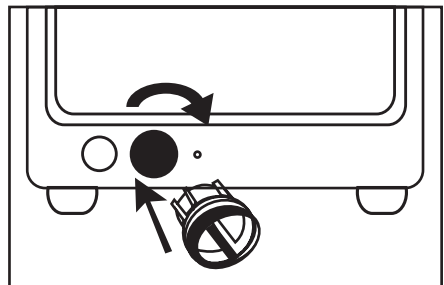

Other Useful Information (Cont.)

Spare parts

Our after sales support centre stocks a wide range of spare parts for the 6kg Top Load Washing Machine. To purchase a part, email us at

info@tempo.org

- Adjuster assembly
- Air trip hose
- Bearing assembly
- Capacitor assembly
- Control circuit board, complete
- Detergent tray
- Drain hose (inside)
- Drain hose assembly (outside)
- Drain pipe
- Feed hose assembly
- Hinge shaft
- Hose band (various)
- Leg
- Lid handle
- Lid spring
- Lint filter assembly
- Motor, complete
- Motor pulley assembly
- Panel sticker
- Pour inlet assembly
- Pulsator
- Pulsator screw
- Pulsator screw washer
- Pulsator washer
- Pump
- Reed switch
- Response switch (water level sensor)
- Safety device switch
- Spring damper base
- Suspension rod, complete
- Suspension rod, complete (motor side)
- Top plate
- Torque motor
- V-belt
- Water valve assembly
- Water valve tie in
- Washer lid
- Washer lid, complete

Other Useful Information (Cont.)

Specifications and technical parameters

Dimensions	520mm (W) x 545mm (D) x 952mm (H)
Capacity (max. weight of dry wash load)	6kg
Weight	31kg
Water quantity (High)	50L
Power source	230-240V~, 50Hz
Power consumption	330W
Required water pressure	0.03MPa – 0.8MPa
Liquid ingress protection	IPX4

Compliance

This appliance has been fully tested and meets all requirements as set out by standards AS/NZS 60335.1 and AS/NZS 60335.2.7



The RCM Mark (Regulatory Compliance Mark) indicates that the product complies with the relevant guidelines of the ACMA as well as corresponding government requirements for the safety of electrical devices.

Responsible disposal

- Packaging materials are recyclable. Please dispose of them responsibly for recycling.
- At the end of its working life, do not throw this appliance out with your household rubbish. Electrical and electronic products contain substances that can have a detrimental effect on the environment and human health if disposed of inappropriately. Observe any local regulations regarding the disposal of electrical consumer goods and dispose of it appropriately for recycling. Contact your local authorities for advice on recycling facilities in your area.

NOTE:

Due to continued product improvement, images and illustrations in this manual may vary slightly from the product purchased. All images in this manual are for reference purposes only. Parts are not necessarily pictured to scale.

Warranty returns

Should you for any reason need to return this product for a warranty claim, make sure to include all accessories with the product.

Product does not work?

If you encounter problems with this product, or if it fails to perform to your expectations, make sure to contact our After Sales Support Centre on 0800 836 761 for advice.

For an electronic copy of this manual, please contact our after sales support centre.

Instruction Manual Revision Index

Version No	Issue Date	Description
V1.0	July 2020	Original release

After Sales Support

☎ (AU) 1300 886 649 (NZ) 0800 836 761 | ✉ info@tempo.org